

Fingerprint Attendance and Access Control Terminal User Guide



* Attention

- 1 . Please cut down the power when install the machine.
- 2 . Please do not install the terminal in direct sunlight or damp environment.
- 3 . Please use 12V/3A or 12V/5A professional access power supply to power on the machine.
- 4 . When the static electricity is serious, please link GND first, and then connect other wires to prevent the static electricity to damage the machine.
- 5 . Please read the terminal wiring diagram carefully, and follow it to link the wires
- 6 . USB flash disk need to use 8G or 16G FAT32 format one, and please format it before use.

Product Appearance

Front

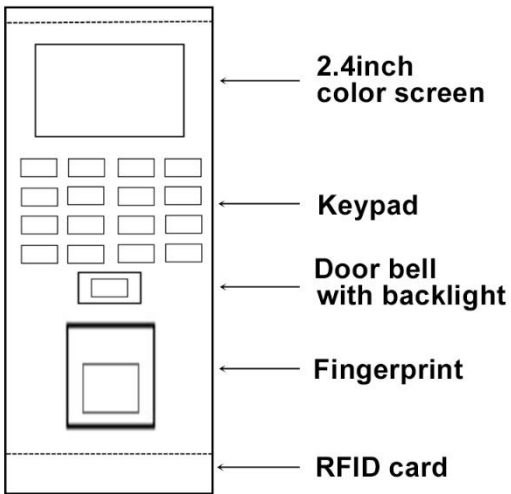

Back

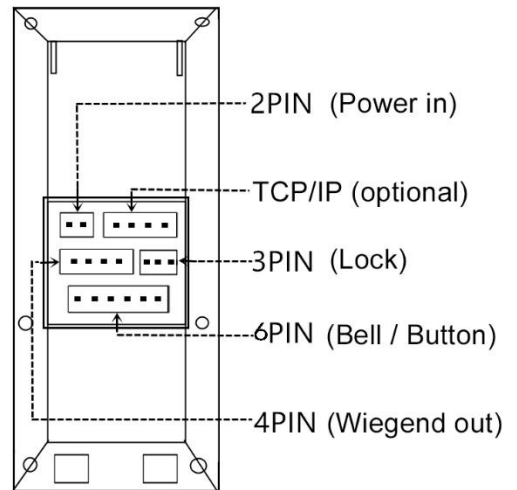

Side

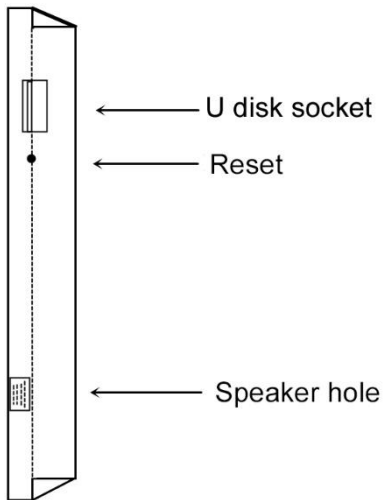

Bottom

Screw hole for fix back plate

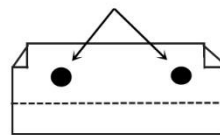

Wiring Diagram

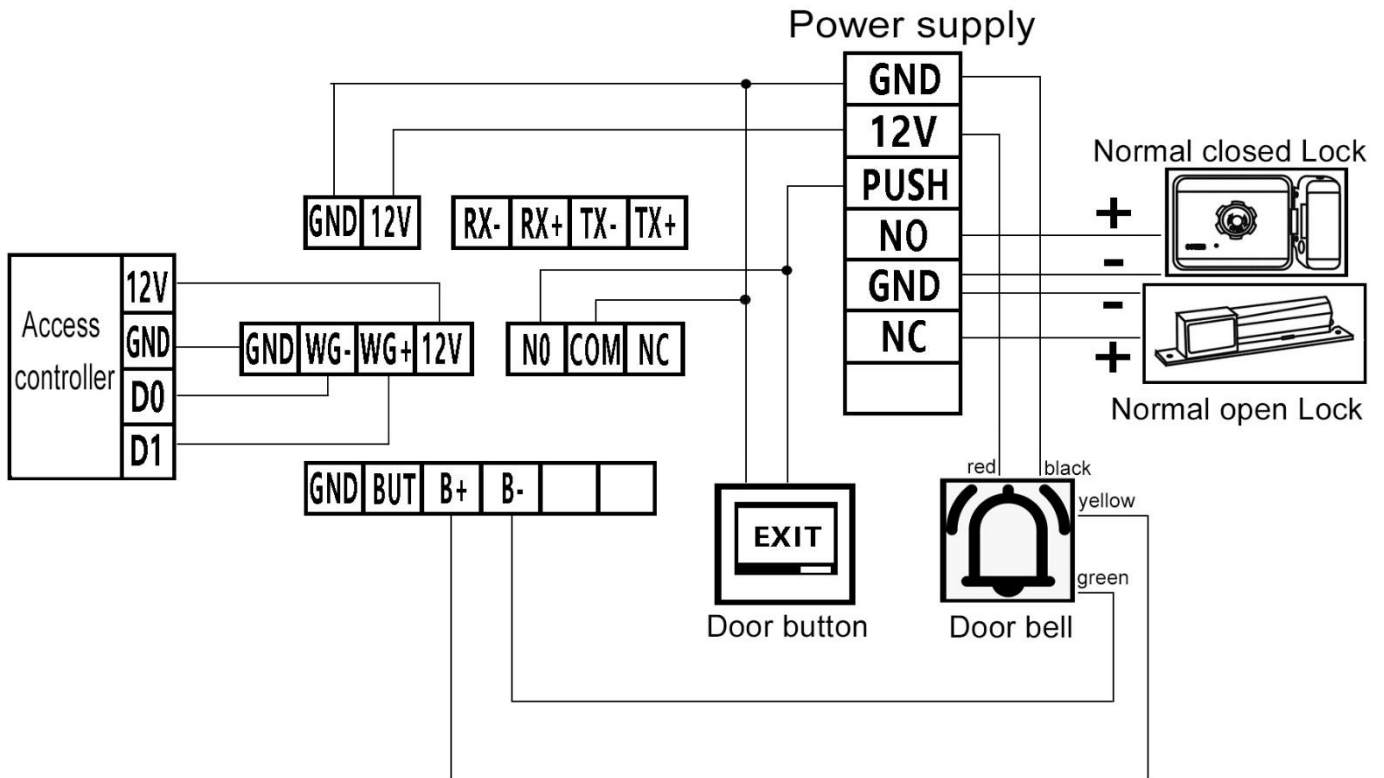

Remark : If you want to link this terminal with access controller, please power on the machine independently. The TCP/IP function is optional function, if you want to use, please tell the supplier when make order, can not add on client side.

Install

1. Fix the iron plate the back side of the machine to the wall.
2. Insert the wiring into the corresponding machine back side of the machine.
3. Hang the machine on the iron plate and fix the screw on the bottom of the machine.

Register

Press MENU> Register

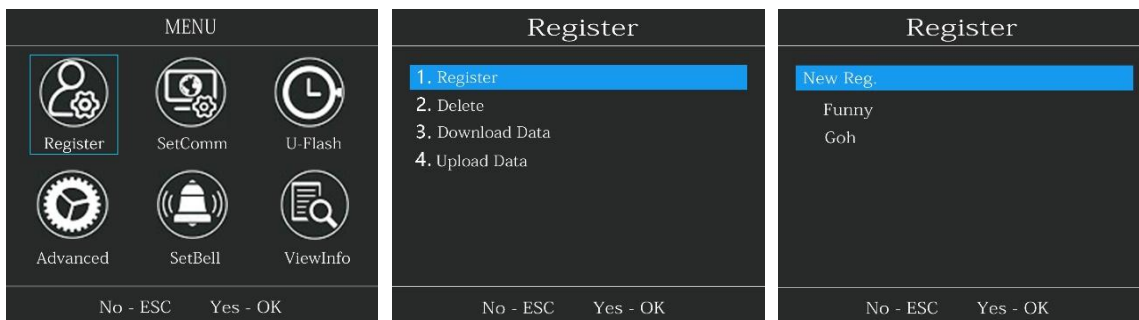

1. Register>New Reg., enter new user interface to set ID, name, Dept., Finger, Pwd, card, Authority(User/Admin) and

Delete, can use T9 input method.

Remark: Add administrator: In Authority option to choose “Admin” (After set administrator only Admin. can enter the menu, please register admins’ finger and password and please remember the ID and password.)

2.Delete user

Register>2. Delete. Input the ID for you want to delete, then choose delete.

3.Download Data

Register>Insert USB flask disk to machine>3. download data, means download all the user’s data to USB flash disk (the file download to USB flash disk name is “001_AFP727.dat”)

4.Upload data

Register>Insert USB flask disk to machine>4. Upload Data. Means upload all the user’s data from USB flash disk to machine.

(the file upload to machine name is“001_AFP727.dat“, please don’t change the file name, otherwise upload will be failed.)

Set time

Press MENU>Advanced>4.SetTime>1. Custom, then can set date and time

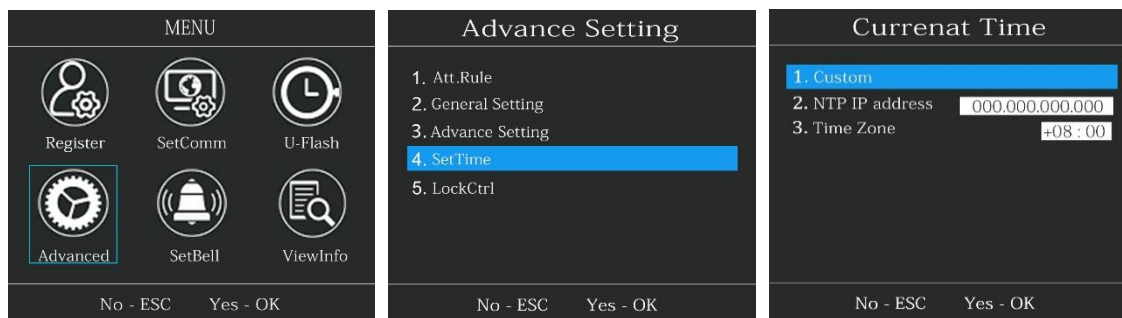

Access control setting

Press MENU>Advanced>5. LockCtrl



1 .Time Setting: Set the time period for user to open the door. We can according to all the user’s access rule to set the in and out time period. The default setting for time period of all users is "period 1" in machine. The time period for "period 1" is “00: 00-23: 59” each day, means 24 hours can open the door every day.

2 .Lock Time: Means how long will it take for the device relay (lock) to reset (lock) after opening, we can set number here, the default is 5 means 5 seconds.

3N.O Time Sec: Here to set the normally open time period of the lock. After set this function, within the set time period the lock will be in normal open state, so will not closed, it will lock again after the end of the time period you set. Default is “NO” means will not use this function.

Manage attendance

Press MENU>U-Flash> Insert USB flash disk

Here can download user information, upload user information, attendance report and download glog.

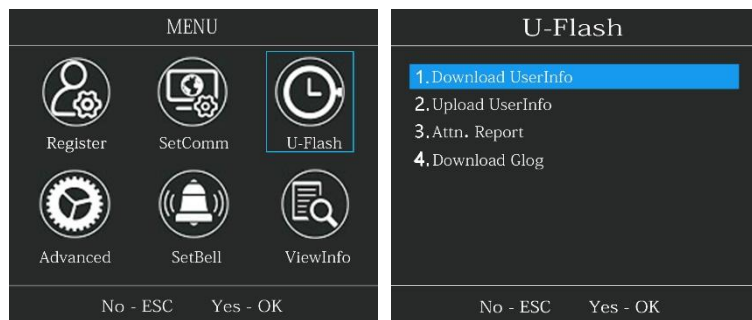

Attendance Rule

Press MENU>Advanced>1. Att.Rule

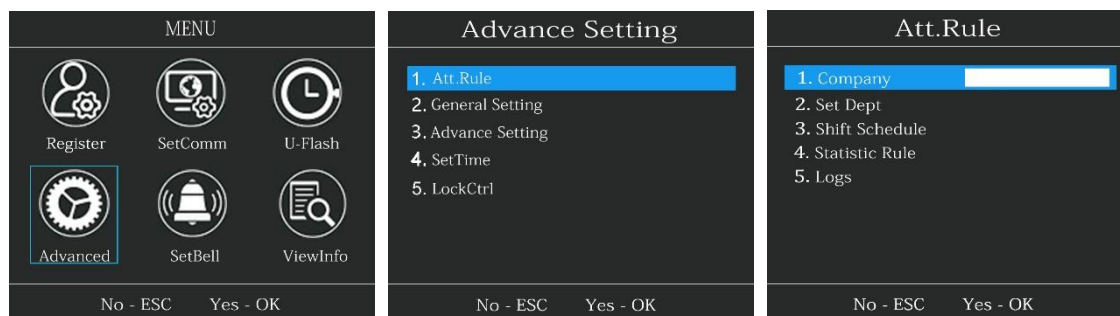

- 1 . Company: Set user’s company name, can use T9 input method.
- 2 . Set Dept: Edit department, totally can set 16 department.
- 3 . Shift Schedule: Set the check in and out time for each department, totally can set 24 shifts, each shift can set 6 attendance time, if no need to take attendance please set “00: 00”.
- 4 . Statistic Rule: Set whether weekend need to take attendance or not and set the late/early leave allowed time. For example: later/early leave time set 5, means late/early leave within 5 minutes will not be recorded late/ early leave.
- 5 . Logs:
 - 1) Set attendance record warning, if set 1000 means when machine record up to 99000 (Machine record capacity is 100000), machine will warning, please backup the attendance record in machine and delete some old record in machine, when the record up to 100000 machine will not record any new attendance record.
【Step for delete record (After delete the record can not be find back, so please backup the records before delete it) : Press MENU>Advanced>3. Advance setting>1. Delete all Rec>OK】 ;
 - 2) Re verify time: Press MENU>Advanced>1. Att. Rule>5. Logs>3. ReVerify.Set how many minutes to check in

multiple times and only fetch (store) the first check-in record, default is 5, means one user check in multiple times in 5 minutes just record the first check in time.

Set Bell

Press MENU> SetBell

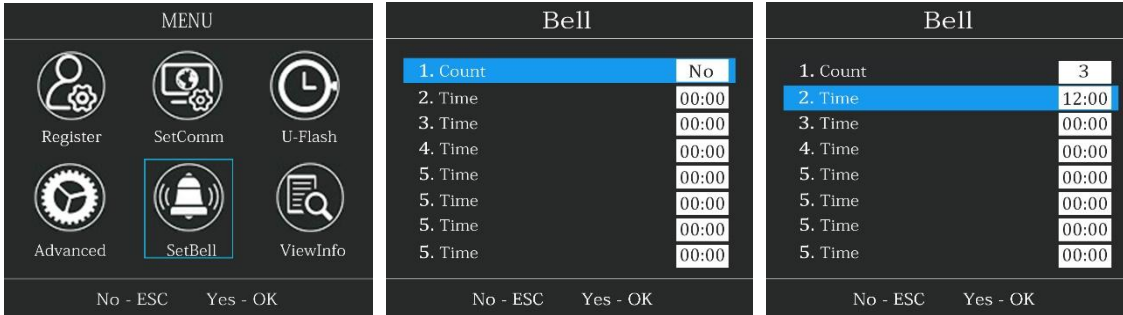

- 1 . Count: Set the bell time, if set 0 and No means don't use bell.
- 2 . Time: Set bell time for each day, Max. can set 8 different bell time. For example: we set Count 3 and time 12:00, means every day when 12:00 bell will ring 3 times.

Simple problems solution

- 1 . Can not verify fingerprint or the verify speed is slow.
 - Please check if your fingerprint sweaty or broken
 - If the scanner humidity or dust or contaminated by other debris.
 - Check if your fingerprint too dry, please puff at your fingerprint and then verify again.
- 2 . Fingerprint or card verify successful but can not open the door.
 - Please check the time period setting is right or not.
 - Please check the N.O. time setting right or not.
 - Please check if the access diagram is right or not
- 3 . When download data machine show failed
 - Please check if the USB flash disk insert right place
 - Please check the USB flash disk is 8G or 16G FAT32
 - Please check if there is some other files in USB flash disk, please delete the file then try again.